



ROBOT PUMPS



RD - SLURRY PUMPS

RD-Slurry Pumps

The Robot wear resistant submersible vortex pumps are designed for the continuous transport of highly abrasive solids. During many years they have proved to be cost effective and most reliable under most extreme working conditions.

The natural low wear figures as experienced in vortex pumps and the limited effect of wear on the pump's output in combination with the absence of wear rings that could impair performance leads to unmatched long term constant high performance with minimal downtime for maintenance. The Robot RD pumps offer low

weight as the selection of the superior Ni Hard 4 wear resistant material does not demand low operating speeds and additionally sacrificing material to achieve long life between service intervals.

Optionally, many pumps can be fitted with an agitator that further increases the density of the pumped mixture.

For the most severe and rough conditions the special dredge version features cable and shaft seal replacement without actually opening the hermetically sealed motor.

Features

Non-clog design

The recessed vortex impeller leaves a wide unobstructed passage through the volute in which a strong vortex is created that carries most of the abrasives. Blockages are hardly possible, even when fibrous materials are included, as these materials are thrown away from the radial blade edges and cannot hook onto the impeller.

Wear resistant Ni Hard 4 - constant high performance

Natural low wear is experienced in vortex pumps as most abrasives pass in front of the impeller without even touching it. Wear is further reduced by using Ni Hard 4 for all hydraulic components. Ni Hard 4 is harder than silica and quartz sand and can withstand shock impacts by rocks. As the impeller does not rely on narrow clearances for high performance, wear will have little effect on the output, resulting in constant high performance over a long period. As the wear pattern will be evenly spread over the impeller, excessive vibration is avoided.

No adjustments - low maintenance

The absence of narrow clearances eliminates jamming problems completely and avoids sudden drops in performance. No re-adjustments are required to restore performance at design level. This ensures reliable, trouble free operation with minimum maintenance and costs.

Agitator for highest density

The optional agitator is mounted just below the intake opening and feeds the impeller with high density material. This in combination with the strong vortex that is created by the impeller just underneath the pump leads to unmatched high solid concentrations. Oversized solids are thrown away from the suction opening, preventing accumulation of solids that would impair performance.

Low weight - easy handling

Long life in the Robot RD pumps is not achieved by reducing the speed and offering additionally sacrificing material, but merely by selecting the superior wear resistant Ni Hard 4 for all hydraulic components. This reduces weight and makes the pumps easier to handle.

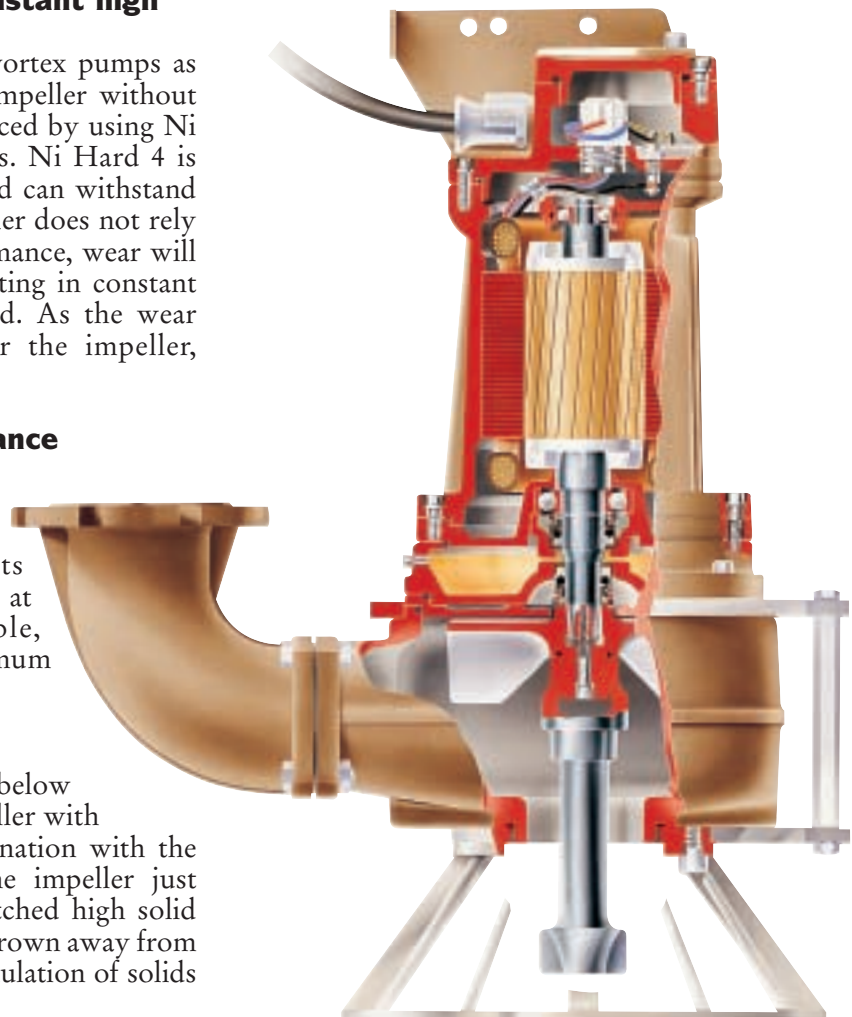

Characteristics

RD20 series

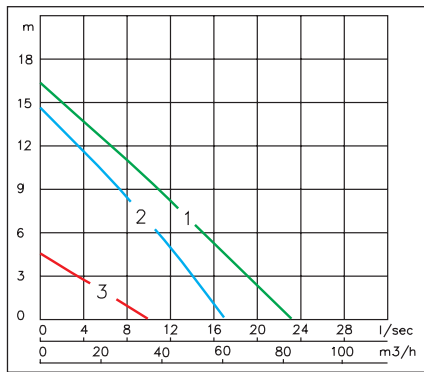

Nr	Model	Motor [kW]	Speed [min ⁻¹]	Outlet [mm]	A [mm]	B [mm]
1	RD2110BH	4	2900	65	345	490
2	RD2110BE	2.6	2900	65	345	490
3	RD2110DA	0.65	1450	65	345	465

RD40 series

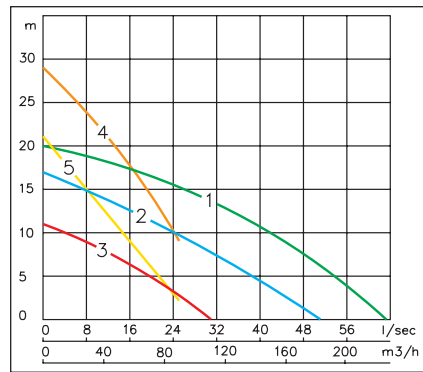

Nr	Model	Motor [kW]	Speed [min ⁻¹]	Outlet [mm]	A [mm]	B [mm]
1	RD4041DZ	13	1450	100	770	960
2	RD4030DO	7.5	1450	100	713	850
3	RD4030DG	3.5	1450	100	713	850
4	RD4021BR	9	2900	65	485	700
5	RD4021BJ	5	2900	65	485	635

RD60 series

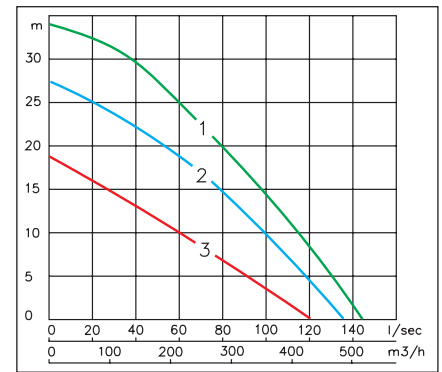

Nr	Model	Motor [kW]	Speed [min ⁻¹]	Outlet [mm]	A [mm]	B [mm]
1	RD6140LL	48	1450	150	855	1175
2	RD6140LI	34	1450	150	855	1100
3	RD6140LF	22	1450	150	855	1040

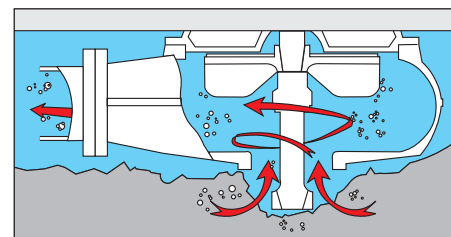
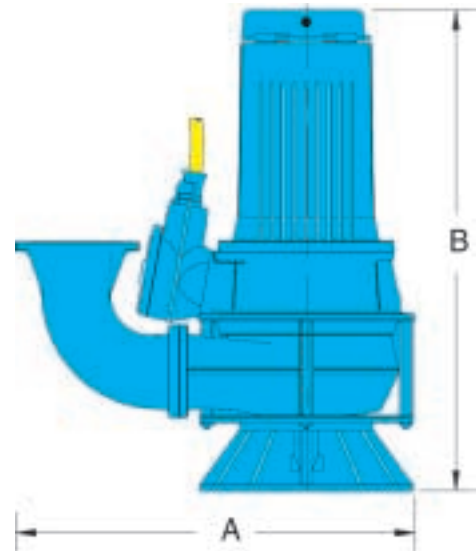

Design Features

Motor: class F (155°F/311°F).

Bearings: heavy duty, greased for life.

Shaft: stainless steel.

Shaft sealing: the seal area is protected from the pump by a special cover plate. Two independent mechanical seals, run in oil. At the pump side silicon carbide runs on ceramic, at the motor side carbon on ceramic.

Oil housing: with flexible rubber bellows.

Back vanes: prevent solids entering the seal area and reduce the pressure on the seals for longer seal life.

Impeller: virtually clog-free vortex type with wide unobstructed passage in front.

No adjustments required: no jamming, constant high performance over a long period, with minimum maintenance.

Bolts & Nuts: stainless steel.

Ni Hard 4: for all hydraulic components. This minimises wear.

Low weight: for ease of handling.

Options available

	Versions		
	Flameproof	Coolingsystem	Agitator
RD2110	●		
RD4021	●	●	
RD4030	●	●	●
RD4041	●	●	●
RD6140	●	●	●

Options

Flame proof motors: certified to European standards EN 50014/18/19 (BS 5501), class EEx de IIB T3 or T4, and to American FMRC standard, class 1, division 1, groups C&D T4.

Cooling jacket: for continuous dry running at full load, for external water supply only. Available for larger pumps. Seal flushing is optional.

Seal leak monitor: detects water ingress in both motor- and oil housing.

Thermostats: standard for all flameproof pumps, pumps with cooling jacket and the dredge versions, optional for all other pumps.

Agitator: feeds impeller with high-density material. Available on larger pumps.

Dredge version: with agitator and hermetically sealed motor with terminal box, to allow cable replacement without opening the motor. Replacement of the mechanical shaft seals without opening the motor is possible.

Products from Robot Pumps B.V.:

Submersible pumps



- RW Vortex Pumps
- RT Turbotex Pumps
- RS Grinder Pumps
- RC Channel Pumps
- RD Slurry Pumps
- RV Heavy Duty Slurry Pumps

RoboSel®

Upon request we have our in house developed program **RoboSel®** available. A handy tool for fast and easy friction loss calculations and alternative system dimensioning. With **RoboSel®** it is easy to select the best suitable pump for your specific application..

Pumps for dry installation

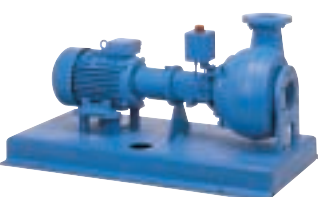

- BW Vortex Pumps
- BT Turbotex Pumps
- BD Slurry Pumps

Typical applications

Sewage

Sewage treatment plants, sewage pumping stations. Sand and grit separators, sludge circulation, sewage high sand content, sewage by-pass, heavy sludge.

Food processing

Wash water, potatoe waste, food and pet food waste, bagasse, sugar beats, canneries.

General industry

Readymix concrete factories, construction industry, dredging, mining, foundries, rolling mills, steel works, power plants, car industry, shipbuilding. Abrasives, recycled concrete, bentonite, cement, coal washing water, coke, coal and ore slurries, drilling and grinding dust, fly ash, mill scales, heavy sand and lime sludge, potash.

Water control

Land reclamation, storm water, harbour sludge, quarries and mines, soil drilling, flood control, ground water, fire fighting water.



Options available

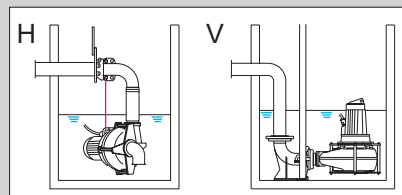

Pumps are available for permanent fixed installation, using the guide rail coupling V or the header coupling H, that is installed above the water level.

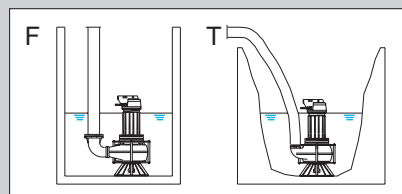

All pumps can be delivered for semi permanent free-standing F or for transportable T installation, with stand and discharge adapter. Also in slim line version.

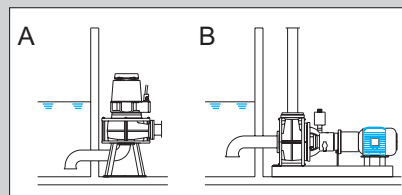

Pumps with cooling system can be used in permanent dry flood-proof immersible installation A, with external water supply only. For conventional dry installation B refer to the BW series brochure.



ROBOT PUMPS

Robot Pumps B.V.

P.O. Box 140, 2400 AC Alphen aan den Rijn
Produktieweg 5, 2404 CC Alphen aan den Rijn
The Netherlands

Phone: +31 172 418686

Fax: +31 172 418602

E-mail: robot.pumps@metso.com

www.robotpumps.com